

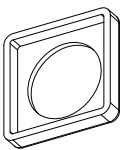

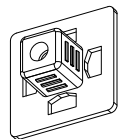

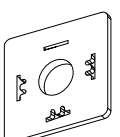

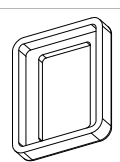

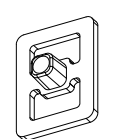
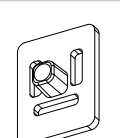
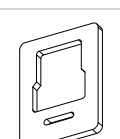
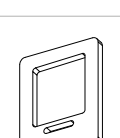
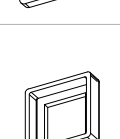
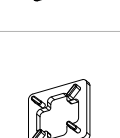



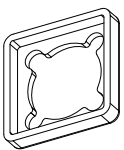
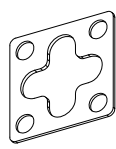
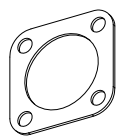
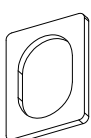
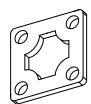
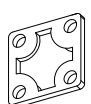

## ACCESSORIES

Technical drawing	Gasket type	Part number	Gasket material	Rated temperature range	Colour	Packaging	Suitable connectors
	Profiled	<b>100013000</b>	NBR	From -40°C to 90°C	Black	50pcs/bag	G1 G1C CG1 CGB
		<b>10001400F</b>	Silicone	From -40°C to 125°C	White		
	Integrated	<b>10001400I</b>	NBR	From -40°C to 90°C	Black	50pcs/bag	G1 G1C CG1 CGB
		<b>10001400M</b>	Silicone	From -40°C to 125°C	White		
	Flat	<b>10001400A</b>	NBR	From -40°C to 90°C	Black	50pcs/bag	G1 G1C CG1 CGB G4 TIMER-DIG
		<b>10001400G</b>	Silicone	From -40°C to 125°C	White		
	Profiled	<b>300013000</b>	NBR	From -40°C to 90°C	Black	50pcs/bag	M1 CM1 M2 CM2
		<b>30001400H</b>	Silicone	From -40°C to 125°C	White		
	Integrated	<b>30001400I</b>	NBR	From -40°C to 90°C	Black	50pcs/bag	CM1
		<b>30001400J</b>	Silicone	From -40°C to 125°C	White		
	Integrated	<b>30001400M</b>	NBR	From -40°C to 90°C	Black	50pcs/bag	CM2
		<b>30001400K</b>	Silicone	From -40°C to 125°C	White		
	Flat	<b>30001400A</b>	NBR	From -40°C to 90°C	Black	50pcs/bag	M1 CM1
		<b>30001400G</b>	Silicone	From -40°C to 125°C	White		
	Flat	<b>30001400N</b>	NBR	From -40°C to 90°C	Black	50pcs/bag	M2 CM2
		<b>30001400P</b>	Silicone	From -40°C to 125°C	White		
	Profiled	<b>500013000</b>	NBR	From -40°C to 90°C	Black	100pcs/bag	P1 CP1 P2 CP2
		<b>50001400F</b>	Silicone	From -40°C to 125°C	White		
	Integrated	<b>50001400I</b>	NBR	From -40°C to 90°C	Black	100pcs/bag	CP1 CP2
		<b>50001400M</b>	Silicone	From -40°C to 125°C	White		

## ACCESSORIES









Valve connector gaskets

Technical drawing	Gasket type	Part number	Gasket material	Rated temperature range	Colour	Packaging	Suitable connectors
	Flat	<b>50001400A</b>	NBR	From -40°C to 90°C	Black	100pcs/bag	P1 CP1 P2 CP2
		<b>50001400G</b>	Silicone	From -40°C to 125°C	White		
	Profiled	<b>100013000A</b>	NBR	From -40°C to 90°C	Black	50pcs/bag	BG5
		<b>100013000D</b>	Silicone	From -40°C to 125°C	White		
	Flat	<b>10001400J</b>	NBR	From -40°C to 90°C	Black	100pcs/bag	BG0 BG1 BG2 BG5 BG8 BG10 BG16 BG33 BG42
		<b>10001400K</b>	Silicone	From -40°C to 125°C	White		
	Flat	<b>10001400H</b>	NBR	From -40°C to 90°C	Black	100pcs/bag	BG0 BG4
		<b>10001400N</b>	Silicone	From -40°C to 125°C	White		
	Flat	<b>30001400E</b>	NBR	From -40°C to 90°C	Black	140pcs/bag	BM1
		<b>30001400F</b>	Silicone	From -40°C to 125°C	White		
	Flat	<b>50001400J</b>	NBR	From -40°C to 90°C	Black	100pcs/bag	BP1
		<b>50001400K</b>	Silicone	From -40°C to 125°C	White		
	Flat	<b>50001400E</b>	NBR	From -40°C to 90°C	Black	100pcs/bag	BP2
		<b>50001400H</b>	Silicone	From -40°C to 125°C	White		

Technical drawing	Thread type	Length	Part number	Screw material	Packaging	Suitable connectors
	M3x0.5	42mm	<b>10001500F</b>	Iron + Zinc plated	50pcs/bag	G4
			<b>10001500F-SS</b>	Iron AISI 304		
	M3x0.5	35mm	<b>10001500R</b>	Iron + Zinc plated	50pcs/bag	CG5
			<b>10001500R-SS</b>	Iron AISI 304		
	M3x0.5	35.4mm	<b>10001500V</b>	Iron + Zinc plated	50pcs/bag	G1C
			<b>10001500V-SS</b>	Iron AISI 304		
	M3x0.5	32.5mm	<b>100015000</b>	Iron + Zinc plated	50pcs/bag	G1 M1 M2
			<b>100015000-SS</b>	Iron AISI 304		
	M2.5x0.5	28mm	<b>50001500A</b>	Iron + Zinc plated	100pcs/bag	P1
			<b>50001500A-SS</b>	Iron AISI 304		
	M3x0.5	28mm	<b>70001500B</b>	Iron + Zinc plated	100pcs/bag	P2
			<b>70001500B-SS</b>	Iron AISI 304		
	M3x0.5	26mm	<b>70001500C</b>	Iron + Zinc plated	50pcs/bag	CM1B
			<b>70001500C-SS</b>	Iron AISI 304		
	M3x0.5	25mm	<b>10001500P</b>	Iron + Zinc plated	50pcs/bag	CG1 G1 Adaptor CM1 M1 Adaptor CM2
			<b>10001500P-SS</b>	Iron AISI 304		
	M3x0.5	22.5mm	<b>70001500P</b>	Iron + Zinc plated	50pcs/bag	CGB CP2 P2 Adaptor
			<b>70001500P-SS</b>	Iron AISI 304		
	M2.5x0.5	22.5mm	<b>50001500P</b>	Iron + Zinc plated	50pcs/bag	CP1 P1 Adaptor
			<b>50001500P-SS</b>	Iron AISI 304		

## ACCESSORIES



Valve connector screws

Technical drawing	Thread type	Length	Part number	Screw material	Packaging	Suitable connectors
	ext.: M4x0.5 int.: M3x0.5	15.5mm	<b>30020500</b>	Iron + Zinc plated	120pcs/bag	BG8 BG10 BG16 BM1
			<b>30020500-SS</b>	Iron AISI 304		
	ext.: M4x0.5 int.: M3x0.5	14mm	<b>30020500A</b>	Iron + Zinc plated	120pcs/bag	BG33 BG42
			<b>30020500A-SS</b>	Iron AISI 304		
	M3x0.5	10mm	<b>100210001</b>	Iron + Zinc plated	200pcs/bag	BG1 BG5
			<b>100210001-SS</b>	Iron AISI 304		
	M3x0.5	8mm	<b>700210001</b>	Iron + Zinc plated	100pcs/bag	BP2
			<b>700210001-SS</b>	Iron AISI 304		
	M2.5x0.5	8mm	<b>500210001</b>	Iron + Zinc plated	100pcs/bag	BP1
			<b>500210001-SS</b>	Iron AISI 304		
	M3x0.5	7.3mm	<b>100210003</b>	Iron + Zinc plated	100pcs/bag	BG0 BG4
			<b>100210003-SS</b>	Iron AISI 304		
	M3x0.5	5mm	<b>300210004*</b>	Iron + Zinc plated	120pcs/bag	BM1
			<b>300210004-SS*</b>	Iron AISI 304		
	M3x0.5	4.8mm	<b>100210002*</b>	Iron + Zinc plated	100pcs/bag	BG1 BG5 BG8 BG10 BG16 BG33 BG42
			<b>100210002-SS*</b>	Iron AISI 304		

\* Screws for P.E.(EARTH) pins.

### NOTES:

- All screws for DIN connectors are provided with different O-rings depending on the products where they are used.
- All O-rings are made in NBR - In case of other O-rings material is requested please contact us to verify the feasibility.
- All Gaskets can't be sold alone, they must be ordered with the connectors or bases corresponding.
- All Screws can't be sold alone, they must be ordered with the connectors or bases corresponding.



Technical drawing	Cap type	Part number	Gasket materials	Colour	Packaging	Suitable connectors
	Male suitable for Female connector	<b>CAPS-12-M-P</b>	PA66	Black	50pcs/bag	M12 Female connectors M12 boxes
	Female SNAP-IN suitable for Male connector	<b>CAPS-12-F-P</b>	PA66	Transparent	50pcs/bag	M12 Male connectors
	Male suitable for Female connector	<b>CAPS-12-M-M</b>	Brass+Nickel plated	Metal	50pcs/bag	M12 Female connectors M12 boxes
	Female suitable for Male connector	<b>CAPS-12-F-M</b>	Brass+Nickel plated	Metal	50pcs/bag	M12 Male connectors
	Male suitable for Female connector	<b>CAPS-08-M-P</b>	PA66	Black	50pcs/bag	M8 Female connectors M8 boxes
	Female SNAP-IN suitable for Male connector	<b>CAPS-08-F-P</b>	PA66	Transparent	50pcs/bag	M8 Male connectors
	Male suitable for Female connector	<b>CAPS-08-M-M</b>	Brass+Nickel plated	Metal	50pcs/bag	M8 Female connectors M8 boxes
	Female suitable for Male connector	<b>CAPS-08-F-M</b>	Brass+Nickel plated	Metal	50pcs/bag	M8 Male connectors
	Female	<b>CAPS BG</b>	PE	White	50pcs/bag	BG bases

## ACCESSORIES

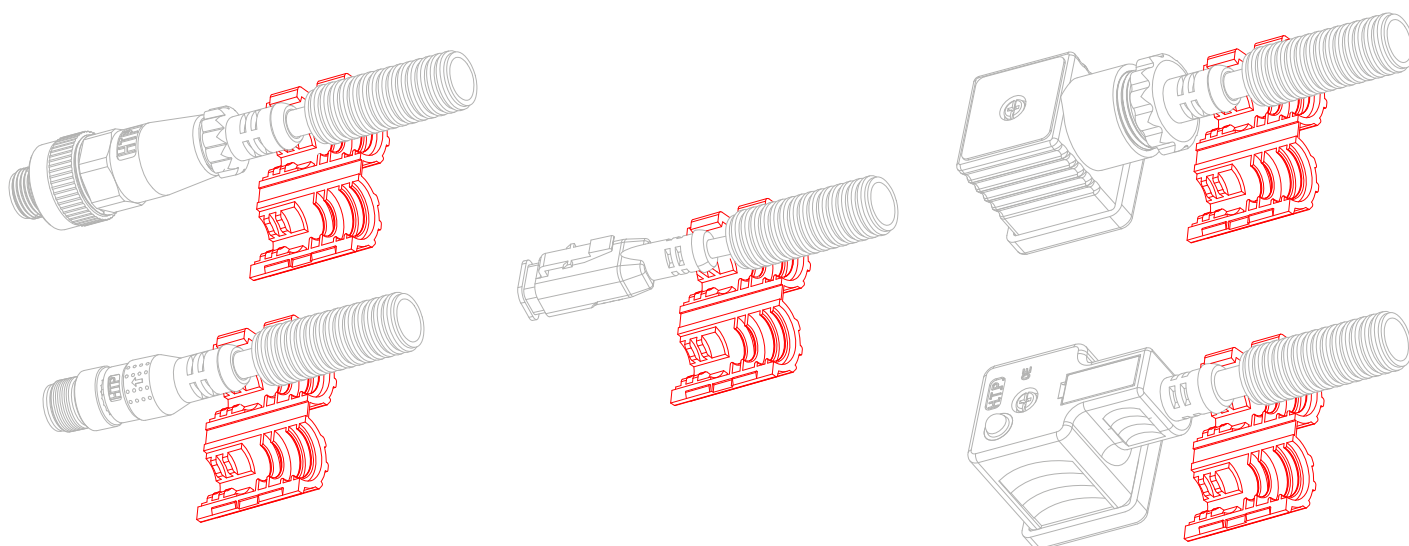

Clip and adapters for corrugated conduit



Technical drawing	Int. conduits diameter	Ext. conduits diameter	Part number	Conduits clip material	Packaging	Suitable connectors
	ø6.2mm and ø9.6mm	ø10mm and ø13mm	<b>ACC1</b>	PA66	50pcs/bag	Din connectors Field attachable* Din connectors with moulded cable Circular M12 connectors Field attachable* Circular M12 connectors with moulded cable Automotive connectors with moulded cable

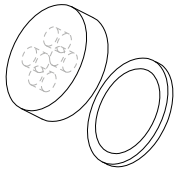
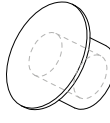
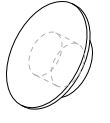
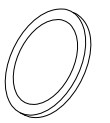

Technical drawing	Gland thread type	Length	Part number	Cable gland	Gland material	Gland colour	Packaging	Suitable connectors
	PG11	29.4mm	<b>ACSC-PG11</b>	6.5-7mm	PA66	Black	50pcs/bag	G1 G1C G4 12ML 12FL 12MU 12FU
	PG9	29mm	<b>ACSC-PG9</b>	4-7mm	PA66	Black	50pcs/bag	M1 M2
	PG7	29mm	<b>ACSC-PG7</b>	3.5-6mm	PA66	Black	50pcs/bag	P1 P2 12FZ 12FC 12MZ 12MC 12FT 12FB 12MT 12MB

\* To connect the conduits clip, all field attachable connectors must have the gland with the exit cable.

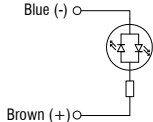
	Round seal with 2 open holes ø5.5mm	<b>1001000C</b>	PVC	Black	50pcs/bag	PG11	G1 G1C G4 12ML 12FL 12MU 12FU
	Round seal with 2 open holes ø2mm	<b>10010000C-2H</b>	PVC PA66	Black	50pcs/bag	PG11	G1 G1C G4 12ML 12FL 12MU 12FU
	Round seal with 4 closed holes + plastic washer easy to break with conductors	<b>10010000F</b>	NBR	Black	50pcs/bag	PG11	G1 G1C G4 12ML 12FL 12MU 12FU
	Seal reduction with 1 closed holes easy to break with conductors	<b>10010000A-SI</b>	PVC	Black	50pcs/bag	PG11	G1 G1C G4 12ML 12FL 12MU 12FU
	Seal reduction with 1 closed holes easy to break with conductors	<b>10010000D</b>	PVC	Black	50pcs/bag	PG7	P1 P2 P3
	Metal Washer	<b>10010000E</b>	Iron	-	50pcs/bag	PG11	G1 G1C G4 12ML 12FL 12MU 12FU

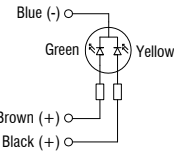
Technical drawing	Technical scheme	Product type	Part number	LED Colour	Packaging	Suitable poles numbers	Suitable connectors
	 <p>Blue (-) ○ Brown (+) ○</p>	Bipolar led + resistance with n°2 wires	<b>ELBO 01</b>	Red	50pcs/bag	2 poles connected	G1 G1C M1 12FT M2 12MT 12MZ 12FZ
	 <p>Blue (-) ○ Green ○ Yellow ○ Brown (+) ○ Black (+) ○</p>	Bicolour led + resistances	<b>ELBO 02</b>	n°1 Yellow n°2 Green	50pcs/bag	3 poles connected	G1 G1C 12MZ 12FZ 12MT 12FT